

## OVERFLATEBEHANDLING AV MA RØR (SMU)

### Eksteriør

Lakkert med rusthindrende acryl primer i rød-brun farge (2).

### Interiør

Belagt med et lag 2-komponent tjære-epoxy i okergul farge (1), gjennomsnittlig tørr tykkelse 130 micron.

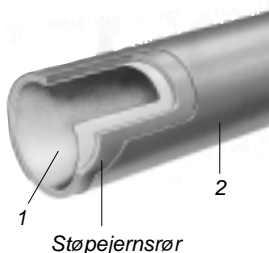

Støpejernsrør

Rør i lengder a 3 m					
DN	Ø	NRF nummer	L mm		Vekt
40	48	200 02 69	3000		8,90
50	58	200 03 19	3000		12,50
75	75	200 04 19	3000		18,30
100	110	200 06 14	2700		23,00
100	110	200 06 19	3000		24,30
125	135	200 07 19	3000		34,30
150	160	200 09 19	3000		40,90
200	210	200 11 19	3000		67,40
250	275	200 14 19	3000		97,30
300	325	200 16 19	3000		126,80
400	429	MU 40 AKF*	3000		177,70
500	532	MU 50 AKF*	3000		244,90
600	635	MU 60 AKF*	3000		321,90

\* Ikke lagervare

### Merking av rør

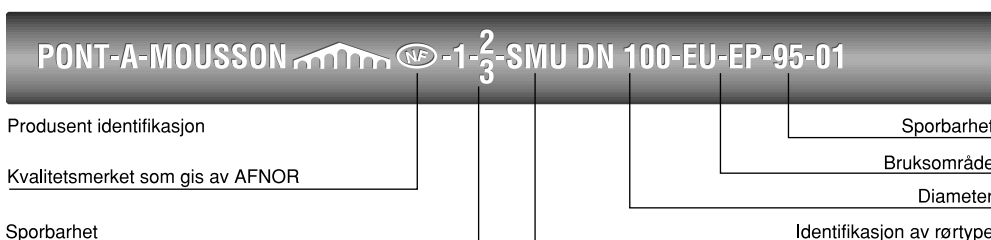

Den internasjonale betegnelsen på PAM's MA-rør er SMU

## OVERFLATEBEHANDLING AV MA-SPESIAL (SMU-HB)

### Eksteriør

Et lag med anti-korrosive zink belegg 130g/m<sup>2</sup> påført med varme (3), deretter lakkert med antracite grå acrylprimer med gjennomsnittlig tørr tykkelse på 40 micron (4).

### Interiør

Belagt med 2 lag 2-komponent okerfarget epoxy (1), med en gjennomsnittlig tørr tykkelse på 250 micron.

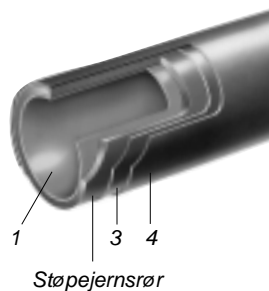

Støpejernsrør

Rør i lengder a 3 m					
DN	Ø	Produkt nr:	L mm		Vekt
50	58	MH 05 AOKZ*	3000		12,70
75	75	MH 07 AOKZ*	3000		18,50
100	110	MH 10 AOKZ*	3000		24,70
125	135	MH 12 AOKZ*	3000		34,80
150	160	MH 15 AOKZ*	3000		41,50
200	210	MH 20 AOKZ*	3000		68,20
250	275	MH 25 AOKZ*	3000		98,30
300	325	MH 30 AOKZ*	3000		128,10
400	428	MH 40 AOKZ*	3000		179,40
500	532	MH 50 AKF*	3000		247,00
600	635	MH 60 AKF*	3000		324,40

\* Ikke lagervare

DN: Nominell diameter

Ø: Utvendig diameter

### Merking av rør

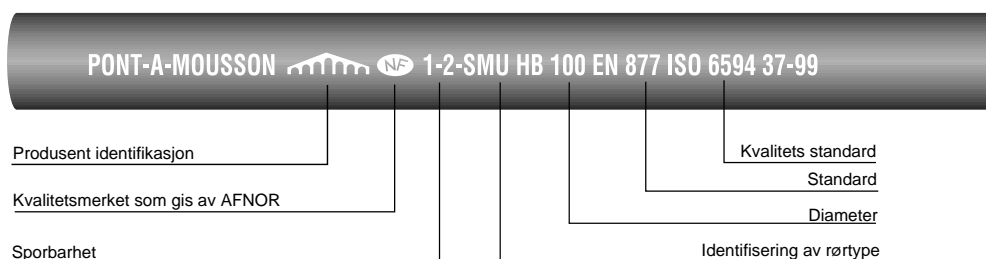

Den internasjonale betegnelsen på PAM's MA-SPESIAL-rør er SMU-HB

For å opprettholde en kontinuerlig produktutvikling forbeholder JOTI AS seg retten til å forandre tekniske spesifikasjoner uten forhåndsvarsel.

Bend 15°



Ø	Art. nr. MA	a=b	radius	Vekt kg	MA-SPECIAL
48	-				-
58	NRF 200 21 09	40		0,4	-
75	NRF 200 21 79	45		0,8	-
110	NRF 200 22 49	50		1,1	-
135	NRF 200 23 19	60		1,8	-
160	NRF 200 23 79	65		2,5	-
210	NRF 200 24 49	80		4,6	-
275	-				-
325	-				-

Bend 22°

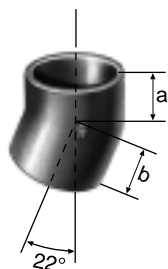

Ø	Art. nr. MA	a=b	radius	Vekt kg	MA-SPECIAL
48	-				-
58	NRF 200 21 14	40	50	0,4	MH 05 C1G*
75	NRF 200 21 84	46,5	60	0,8	MH 07 C1G*
110	NRF 200 22 54	54	72	1,3	MH 10 C1G*
135	NRF 200 23 24	61,5	82	1,9	MH 12 C1G*
160	NRF 200 23 84	68,5	95	2,5	MH 15 C1G*
210	NRF 200 24 52	85	120,5	4,3	MH 20 C1G*
275	MU 23 C1GC*	100	144,5	9,5	MH 25 C1G*
325	MU 30 C1GC*	115	170	15,3	MH 30 C1G*

\* Ikke lagervare

Bend 30°



Ø	Art. nr. MA	a=b	radius	Vekt kg	MA-SPECIAL
48	-				-
58	NRF 200 21 19	45		0,4	-
75	NRF 200 21 89			0,8	-
110	NRF 200 22 59	60		1,3	-
135	NRF 200 23 29	76		2,3	-
160	NRF 200 23 89	80		3,0	-
210	NRF 200 24 54	95		5,4	-
275	-				-
325	-				-

Bend 45°

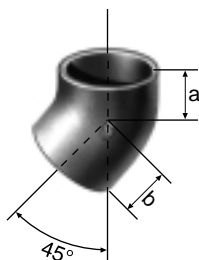

Ø	Ø2	Art. nr. MA	a=b	radius	Vekt kg	MA-SPECIAL
48		NRF 200 20 73	45	35	0,4	-
50	58	NRF 200 52 19			0,4	-
58		NRF 200 21 24	50	48	0,5	MH 05 C1D*
75		NRF 200 21 94	60	60	1,0	MH 07 C1D*
110		NRF 200 22 64	70	72	1,5	MH 10 C1D*
135		NRF 200 23 34	80	84,5	2,2	MH 12 C1D*
160		NRF 200 23 94	90	96,5	3,3	MH 15 C1D*
210		NRF 200 24 64	110	120,5	5,7	MH 20 C1DZ*
275		NRF 200 25 69*	130	144,5	9,6	MH 30 C1D*
325		NRF 200 26 39*	155	181	16,4	-
400		MU 40 C1DC			34,34	MH 40 C1D

DN 500 og 600 er tilgjengelige på forespørsel.

\* Ikke lagervare

**Bend 67,5°**

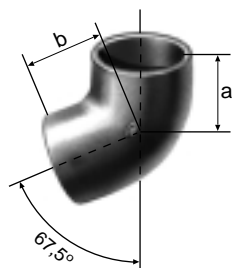

Ø	Art. nr. MA	a=b	radius	Vekt kg	MA-SPECIAL
48	-				-
58	NRF 200 21 29	70	58	0,75	MH 05 C1C*
75	NRF 200 21 99	80	60	1,2	MH 07 C1C*
110	NRF 200 22 69	90	75,5	1,8	MH 10 C1C*
135	NRF 200 23 39	105	87	3,0	MH 12 C1C*
160	NRF 200 23 99	120	101,5	4,0	MH 15 C1C*
210	NRF 200 24 69	145	123,5	7,8	MH 20 C1C*
275	NRF 200 25 74	170	145,5	13,9	MH 25 C1C*
325	NRF 200 26 44	200	174,5	20,3	MH 30 C1C*

\* Ikke lagervare

**Bend 87,5°**

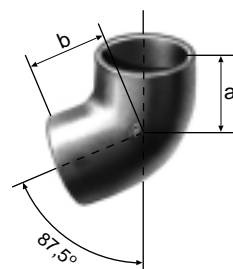

Ø	Art. nr. MA	a=b	radius	Vekt kg	MA-SPECIAL
48	NRF 200 20 79	65	35	0,5	-
58	NRF 200 21 39	75	46,5	0,75	MH 05 C1A*
75	NRF 200 22 09	95	62,5	1,45	MH 07 C1A*
110	NRF 200 22 79	110	72,5	2,35	MH 10 C1A*
135	NRF 200 23 44	125	82,5	3,1	MH 12 C1A*
160	NRF 200 24 09	145	98	4,6	MH 15 C1A*
210	NRF 200 24 79	180	124	8,1	MH 20 C1A*
275	NRF 200 25 84	220	154	13,5	MH 25 C1A*
325	NRF 200 26 54	260	185	20,7	MH 30 C1A*

\* Ikke lagervare

**Bend 87,5° stor radius**

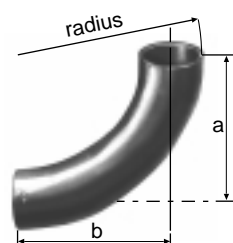

Ø	Art. nr. MA	a=b	radius	Vekt kg	MA-SPECIAL
48	-				-
58	-				-
75	-				-
110	MU 10 C7AC*	268,5	323	4,4	-
135	-				-
160	MU 15 C7AC*	290	349	8,0	-
210	-				-
275	-				-
325	-				-

Bend i 87,5° med stor radius vil tilsvare å bruke 2 stk. bend à 45°.

\* Ikke lagervare

**Gummihefter EPDM ogSMU : servantanslutninger**

EPDM 1 og 2 anboringer

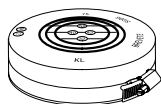

**NRF 200 66 29**

75 x 32/40/42/50 mm

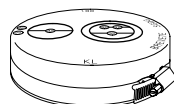

**NRF 200 66 39**

110 x 32/40/42 mm

DN	Varenummer	1. Anboring	2. Anboring
58	NRF 200 66 19	32/40 mm	
75	NRF 200 66 29	32/40 mm 42/50 mm	
110	NRF 200 66 39	32/40 mm	32 mm

For å opprettholde en kontinuerlig produktutvikling forbeholder JOTI AS seg retten til å forandre tekniske spesifikasjoner uten forhåndsvarsel.

**Enkle grenrør 45°**

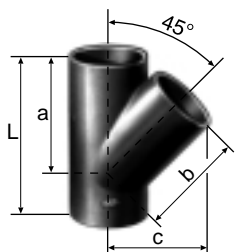

Ø		Art. nr. MA	L	a	b	c	Vekt kg	MA-SPECIAL
48		NRF 200 31 49	150	105	115	99	0,75	MH 05 Y1D*
58		NRF 200 31 69	165	120	145	123	1,15	MH 05 Y1D*
75		NRF 200 32 29	215	155	155	139	2,35	MH 07 Y1D*
110		NRF 200 33 29	260	190	190	174	3,95	MH 10 Y1D*
135		NRF 200 33 89	305	230	230	211	5,8	MH 12 Y1D*
160		NRF 200 34 69	355	265	265	244	8,7	MH 15 Y1D*
210		NRF 200 35 69	455	340	346	320	15,8	MH 20 Y1D*
275		NRF 200 36 49	560	430	430	401	32,8	MH 25 Y1D*
325		NRF 200 37 09	660	505	505	473	50,6	MH 30 Y1D*

\* Ikke lagervare

**Enkle grenrør med mindre sideløp 45°**

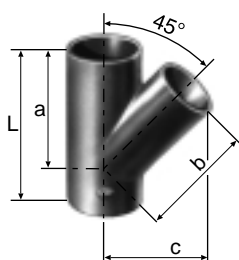

Ø	Ø2	Art. nr. MA	L	a	b	c	Vekt kg	MA-SPECIAL
58	48	NRF 200 31 59	155	110	125	102	1,1	–
75	58	NRF 200 32 09	180	135	135	116	1,8	MH 07 E1D*
110	58	NRF 200 32 89	185	150	150	127	2,3	MH 10 E1D*
110	75	NRF 200 33 09	220	170	170	150	3,05	MH 10 E3D*
135	110	NRF 200 33 69	270	210	210	188	4,8	MH 12 E3D*
160	110	NRF 200 34 29	280	225	225	198	6,1	MH 15 E5D*
160	135	NRF 200 34 49	315	245	245	221	7,3	MH 15 E6D*
210	110	NRF 200 35 09	300	260	260	223	8,25	MH 20 E5D*
210	160	NRF 200 35 49	375	300	300	269	12,2	MH 20 E7D*
275	210	NRF 200 36 29	470	380	380	343	20,2	MH 25 E1DZ*
325	275	NRF 200 36 89	580	465	465	426	37,2	MH 30 E9D*
400	300	MU 40 E7DC*	660				55,3	MH 40 E1DA
500	300	MU 50 E7DC*	720				86,0	
600	300	MU 60 E7DC*	725				100,0	

\* Ikke lagervare

**Enkle grenrør 67,5°**

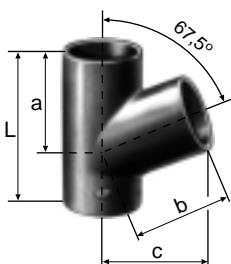

Ø		Art. nr. MA	L	a	b	c	Vekt kg	MA-SPECIAL
58		NRF 200 31 74	145	85	85	90	1,1	MH 05 Y1C*
75		NRF 200 32 34	180	110	110	118	2,35	MH 07 Y1C*
110		NRF 200 33 34	220	130	130	141	2,95	MH 10 Y1C*
135		NRF 200 33 94	255	155	155	169	4,45	MH 12 Y1C*
160		NRF 200 34 74	295	180	180	197	6,65	MH 15 Y1C*
210		NRF 200 35 74	365	225	225	248	13,2	MH 20 Y1C*
275		NRF 200 36 54	460	285	285	320	20,1	MH 25 Y1C*
325		NRF 200 37 14	545	345	345	380	34,5	MH 30 Y1C*

\* Ikke lagervare

**Enkle grenrør med mindre sideløp 67,5°**

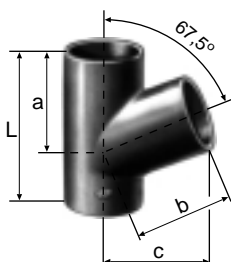

Ø	Ø2	Art. nr. MA	L	a	b	c	Vekt kg	MA-SPECIAL
75	58	MU 07 E0CC*	155	95	95	99	1,4	MH 07 E1C*
110	58	NRF 200 32 94	155	100	110	113	1,8	MH 10 E1C*
110	75	NRF 200 33 14	185	115	125	132	2,4	MH 10 E3C*
135	110	NRF 200 33 74	225	140	145	155	4,1	MH 12 E5C*
160	110	NRF 200 34 34	235	150	155	165	5,3	MH 15 E5C*
160	135	NRF 200 34 54	265	166	170	183	6,5	MH 15 E6C*
210	160	NRF 200 35 54	310	200	210	225	9,5	MH 20 E7C*
275	210	NRF 200 36 34	390	255	265	285	17,1	–
325	275	NRF 200 36 94	485	315	320	348	31,0	–

\* Ikke lagervare

**Enkle grenrør 87,5°**

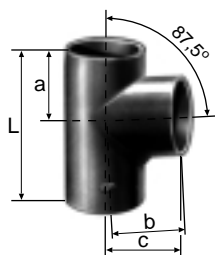

Ø	Art. nr. MA	L	a	b	c	Vekt kg	MA-SPECIAL
48	–						–
58	NRF 200 31 79	145	65	80	81	1,0	MH 05 Y1A*
75	NRF 200 32 39	180	85	95	97	1,95	MH 07 Y1A*
110	NRF 200 33 39	220	105	115	117	2,9	MH 10 Y1A*
135	NRF 200 33 99	255	125	135	138	4,5	MH 12 Y1A*
160	NRF 200 34 79	295	145	155	158	6,5	MH 15 Y1A*
210	NRF 200 35 79	365	180	180	184	11,1	MH 20 Y1A*
275	NRF 200 36 59	455	225	225	230	18,5	MH 25 Y1A*
325	NRF 200 37 19	530	265	265	271	34,0	MH 30 Y1A*

\* Ikke lagervare

**Enkle grenrør med mindre sideløp 87,5°**

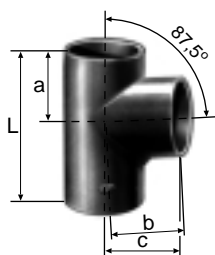

Ø	Ø2	Art. nr. MA	L	a	b	c	Vekt kg	MA-SPECIAL
48		–						–
58		–						–
75	58	NRF 200 32 19	160	75	90	93	1,45	MH 07 E1A*
110	58	NRF 200 32 99	170	75	105	107	2,1	MH 10 E1A*
110	75	NRF 200 33 19	190	90	110	112	2,55	–
160	110	NRF 200 34 39	220	105	140	143	4,9	–
210		–						–
275		–						–
325		–						–

\* Ikke lagervare

**Forlenget grenrør**

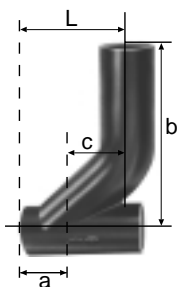

Ø	Art. nr. MA	L	a	b	c	Vekt kg	MA-SPECIAL
48	–						–
58	–						–
75	–						–
110	NRF 200 38 56	260	70	395	156,8	6,3	–
135	–						–
160	–						–
210	–						–
275	–						–
325	–						–

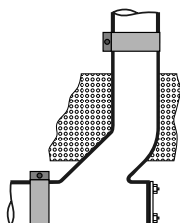

Forlenget grenrør kan brukes både som stående og liggende installasjon for å unngå at skjøt kommer i konflikt med vegg eller etasjeskiller.

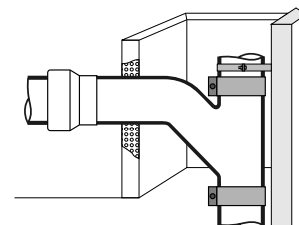

For å opprettholde en kontinuerlig produktutvikling forbeholder JOTI AS seg retten til å forandre tekniske spesifikasjoner uten forhåndsvarsel.

**Etasjegren 45°**

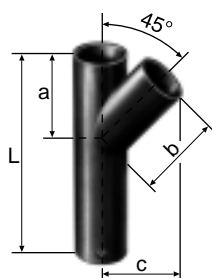

Ø	Art. nr. MA	L	a	b	c	Vekt kg	MA-SPESIAL
48	–						–
58	–						–
75	–						–
110	NRF 200 38 49	430	190	190	174	5,2	MH 10Y1DL*
135	–						–
160	MU 15 Y7DC*	705	265	265	244	14,0	MH 15Y1DL*
210	MU 20 Y7DC*	770	340	346	320	24,0	MH 20Y1DL*
275	–						–
325	–						–

\* Ikke lagervare

**Etasjegren 67,5°**

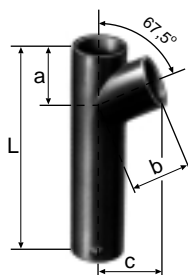

Ø	Art. nr. MA	L	a	b	c	Vekt kg	MA-SPESIAL
48	–						–
58	–						–
75	–						–
110	NRF 200 38 54	460	130	130	140	5,4	MH 10 Y1CL*
135	–						–
160	–						–
210	–						–
275	–						–
325	–						–

\* Ikke lagervare

**Gjennomføring i etasjeskiller**

Ved bruk av etasjegren unngås det at skjøt mellom stående rør og grenrør kommer i konflikt med etasjeskillet. Man oppnår her en gjennomføring uten skjøt slik det kreves av forskriftene.

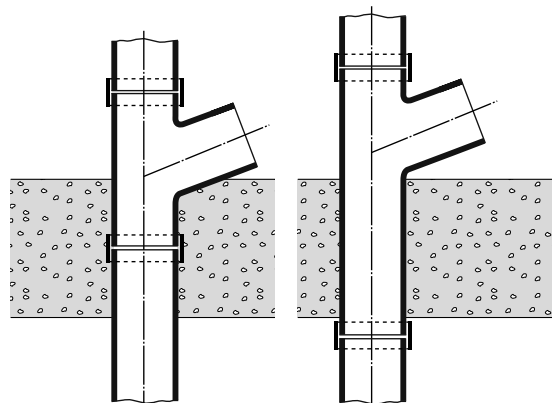

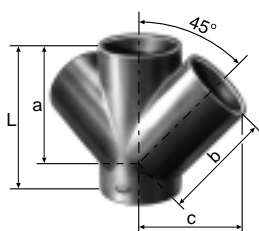
**Dobbelt grenrør 45°**

Ø		Art. nr. MA	L	a	b	c	Vekt kg	MA-SPECIAL
48		-						-
58		-						-
75		-						-
110		NRF 200 41 27*	260	190	190	174	4,55	MH 10 Y2D*
135		NRF 200 41 58*	305	230	230	211	7,25	MH 12 Y2D*
160		NRF 200 42 22*	355	265	265	244	10,65	MH 15 Y2D*
210		-						-
275		-						-
325		-						-

\* Ikke lagervare

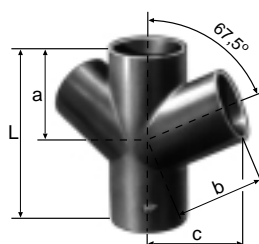
**Dobbelt grenrør 67,5°**

Ø		Art. nr. MA	L	a	b	c	Vekt kg	MA-SPECIAL
48		-						-
58		MU 05 Y2CC*	145	85	85	90	1,5	MH 05 Y2C*
75		MU 07 Y2CC*	180	110	110	118	2,0	MH 07 Y2C*
110		NRF 200 41 29	220	130	130	141	3,9	MH 10 Y2C*
135		NRF 200 41 69	255	155	155	169	5,95	MH 12 Y2C*
160		NRF 200 42 24	295	180	180	197	8,9	MH 15 Y2C*
210		NRF 200 42 64	365	225	225	248	14,8	MH 20 Y2C*
275		-						-
325		-						-

\* Ikke lagervare

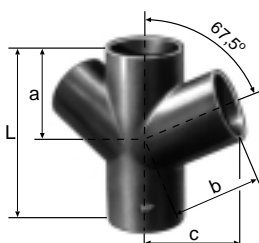
**Dobbelt grenrør med mindre sideløp 67,5°**

Ø	Ø2	Art. nr. MA	L	a	b	c	Vekt kg	MA-SPECIAL
48		-						-
58		-						-
75	58	MU 07 D0CC*	155	95	95	99	1,6	MH 07 D1C*
110	75	MU 10 D1CC*	185	115	125	132	3,0	MH 10 D3C*
135	110	NRF 200 41 49	225	140	145	155	4,6	MH 12 D5C*
160	135	NRF 200 42 05	265	165	170	183	6,8	MH 15 D6C*
210	160	MU 20 D4CC*	310	200	210	225	9,1	MH 20 D7C*
275		-						-
325		-						-

\* Ikke lagervare

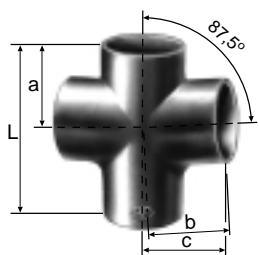
**Dobbelt grenrør 87,5°**

Ø		Art. nr. MA	L	a	b	c	Vekt kg	MA-SPECIAL
48		-						-
58		-						-
75		-						-
110		NRF 200 41 34	220	105	115	117	3,2	MH 10 Y2A*
135		-						-
160		-						-
210		-						-
275		-						-
325		-						-

\* Ikke lagervare

For å opprettholde en kontinuerlig produktutvikling forbeholder JOTI AS seg retten til å forandre tekniske spesifikasjoner uten forhåndsvarsel.

**Hjørnegrenrør 45°**

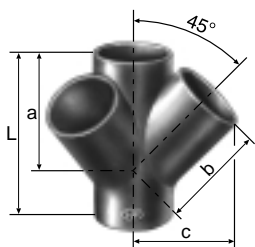

Ø	Art. nr. MA	L	a	b	c	Vekt kg	MA-SPECIAL
48	–						–
58	–						–
75	–						–
110	NRF 200 44 43	260	190	190	174	4,4	MH 10 Y3D*
135	–						–
160	–						–
210	–						–
275	–						–
325	–						–

\* Ikke lagervare

**Hjørnegrenrør 67,5°**

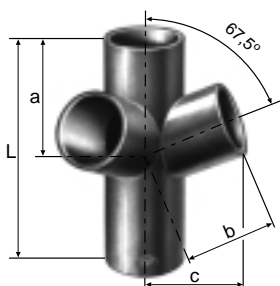

Ø	Art. nr. MA	L	a	b	c	Vekt kg	MA-SPECIAL
48	–						–
58	–						–
75	MU 07 Y3CC*	180	110	110	118	2,3	MH 07 Y3C*
110	NRF 200 44 44	220	130	130	141	3,6	MH 10 Y3C*
135	–						–
160	–						–
210	–						–
275	–						–
325	–						–

\* Ikke lagervare

**Hjørnegrenrør 87,5°**

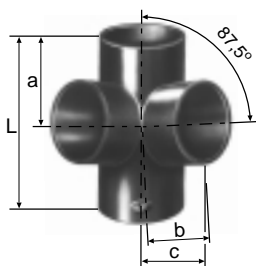

Ø	Art. nr. MA	L	a	b	c	Vekt kg	MA-SPECIAL
48	–						–
58	–						–
75	–						–
110	NRF 200 44 49	220	105	115	115	3,4	–
135	–						–
160	–						–
210	–						–
275	–						–
325	–						–

**Ekspansjonsplugg**

Ø	Art. nr. MA	L	Vekt kg	MA-SPECIAL
48	–			–
58	MU 05 B1AC*	33	0,29	MH 05 B1AC*
75	MU 07 B1AC*	52	0,6	MH 07 B1AC*
110	MU 10 B1AC*	55	1,1	MH 10 B1AC*
135	MU 12 B1AC*	53	1,5	MH 12 B1AC*
160	MU 15 B1AC*	53	2,1	MH 15 B1AC*
210	MU 20 B1AC*	63	4,1	MH 20 B1AC*
275	MU 25 B1AC*	53	6,0	MH 25 B1AC*
325	MU 30 B1AC*	56	9,1	MH 30 B1AC*

\* Ikke lagervare

**Propp, støpejern**

Ø	Art. nr. MA	L	Vekt kg	MA-SPECIAL
48	–			–
58	NRF 200 57 19	30	0,25	–
75	NRF 200 57 29	35	0,45	–
110	NRF 200 57 39	40	0,8	–
135	NRF 200 57 49	45	1,2	–
160	NRF 200 57 59	50	1,7	–
210	NRF 200 57 69	60	3,2	–
275	NRF 200 57 84	70	5,9	–
325	NRF 200 57 94	80	9,4	–

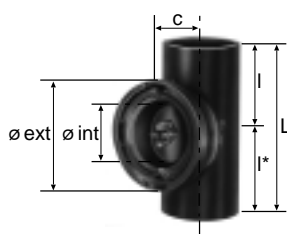
**Stakerør**

Ø	Art. nr. MA	L	c	Ø innv.	Ø utv.	Vekt kg	MA-SPECIAL
48	–						–
58	NRF 200 55 19	160	73	75	108	1,95	MH 05 ROB*
75	MU 07 ROBC*	205	89	101	134	3,0	MH 07 ROB*
110	MU 10 ROBC*	250	102	128	160	4,45	MH 10 ROB*
135	NRF 200 55 49	280	125	154	189	6,7	MH 12 ROB*
160	NRF 200 55 59	320	142	181	224	10,0	MH 15 ROB*
210	NRF 200 55 69	360	165	181	224	11,7	MH 20 ROB*
275	NRF 200 55 84	380	196	181	225	17,6	MH 25 ROB*
325	NRF 200 55 94	400	222	181	227	22,25	MH 30 ROB*

\* Ikke lagervare

**Stakerør med firkantlukke**

Ø	Art. nr. MA	L	c	□ innv.	□ utv.	Vekt kg	MA-SPECIAL
48							
58							
75	NRF 200 55 29	262	93	112x75	93x56	3,5	–
110	NRF 200 55 39	267	106	113x113	110x91	4,9	–
135							
160							
210							
275							
325							

For å opprettholde en kontinuerlig produktutvikling forbeholder JOTI AS seg retten til å forandre tekniske spesifikasjoner uten forhåndsvarsel.

Eksentrisk overgangsrør



Ø	Ø2	Art. nr. MA	L1	L2		Vekt kg	MA-SPECIAL
58	48	NRF 200 49 18	80			0,3	–
58	50	NRF 200 54 19	100			0,5	–
75	58	NRF 200 49 24	75			0,6	MH 05 V3B*
110	58	NRF 200 49 29	80			1,0	MH 05 V5B*
110	75	NRF 200 49 34	85			1,1	MH 07 V5B*
135	75	–	95			1,6	MH 07 V6B*
135	110	NRF 200 49 39	95			1,6	MH 10 V6B*
160	75	–	100			2,2	MH 07 V7B*
160	110	NRF 200 49 44	105			2,3	MH 10 V7B*
160	135	NRF 200 49 49	110			2,4	MH 12 V7B*
210	75	–	115			3,9	MH 07 V8B*
210	110	NRF 200 50 05	115			4,0	MH 10 V9A*
210	135	NRF 200 50 09	120			4,0	MH 12 V9A*
210	160	NRF 200 50 14	125			4,2	MH 15 V9B*
275	75	–	125			6,7	MH 07 V9B*
275	110	NRF 200 50 29	125			6,7	MH 10 V9B*
275	160	NRF 200 50 34	135			6,8	MH 15 V1A*
275	210	NRF 200 50 39	145			6,9	MH 20 V1A*
325	110	NRF 200 50 49	140	97		10,5	MH 10 V2A*
325	160	NRF 200 50 54	150	95		9,7	MH 15 V2A*
325	210	NRF 200 50 59	160	97		9,7	MH 20 V2A*
325	275	NRF 200 50 69	170	95		10,1	MH 25 V1A*
400	325	MU 30 V8AC*	200	100		19,7**	MH 30 V1A*
500	325	MU 50 V8AC*	200	100		27,9	
500	400	MU 50 V9AC*	200	100		28,9	
600	400	MU 60 V9AC*	200	100		38,0	
600	500	MU 60 V10AC*	200	100		37,5	

\* Ikke lagervare

\*\* Vekt gjelder normal MA, vekt for Super MA er 20,28 kg.

Vannlås

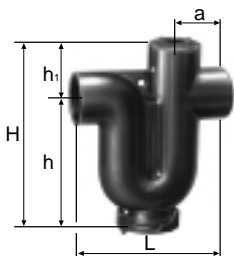

DN	dn	Art. nr. MA	L	a	H	h/h <sub>1</sub>	Vekt kg	MA-SPECIAL
58		NRF 200 80 19	190	68	240	172/68	2,70	MH 05 S1A*
75		NRF 200 80 29	265	93	282	189/93	5,80	MH 07 S1A*
110		NRF 200 80 39	325	110	381	271/110	9,40	MH 10 S2A*
135		NRF 200 80 49	390	130	435	305/130	13,10	MH 12 S2A*
160		NRF 200 80 59	470	145	482	337/145	21,80	MH 15 S1A*
210		MU 20 S1AC*	600	210	500	355/145	27,60	MH 20 S1A*

\* Ikke lagervare

Alternativ montasjer:

Horisontal

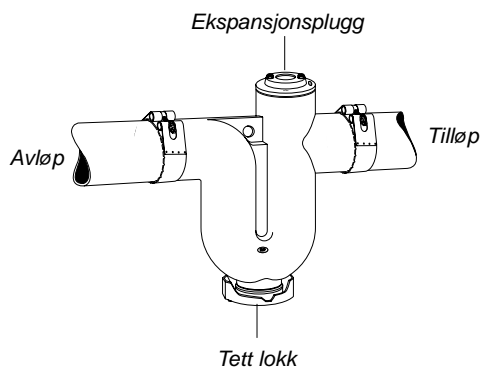

Vertikal

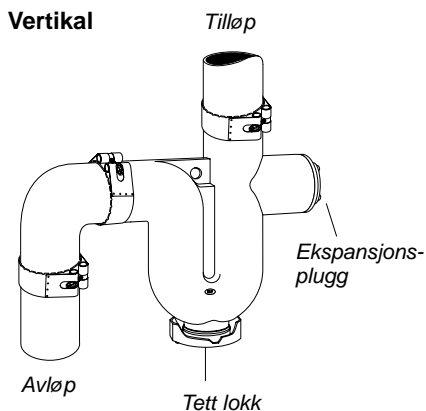

WC grenrør



DN	dn	Art. nr. MA	Tilslutning	Vekt kg
110		NRF 200 70 54	venstre	7,0
110		NRF 200 70 55	høyre	7,0

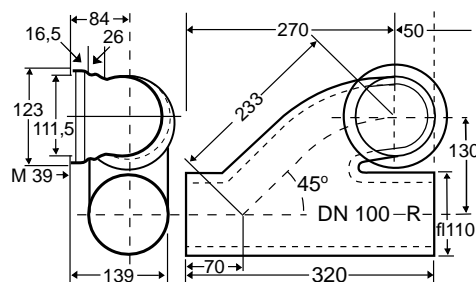

Tegning viser grenrør med høyretilkobling

WC bend



DN	dn	Art. nr. MA	X <sub>1</sub>	X <sub>2</sub>	Vekt kg
110		NRF 200 70 51	150	44	2,6

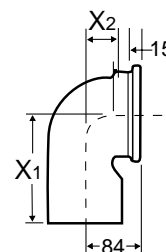

WC dobbeltbend



DN	dn	Art. nr. MA	X <sub>1</sub>	X <sub>2</sub>	A	K	Vekt kg
110		NRF 200 70 52	225	85	250	50	5,7

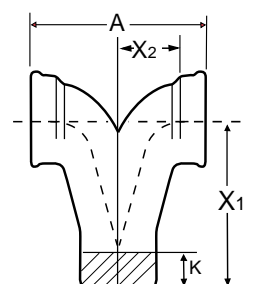

WC dobbeltbend for grenrør



DN	dn	Art. nr. MA	X <sub>1</sub>	X <sub>2</sub>	K	Vekt kg
110		NRF 200 70 53	295	100	90	8,3

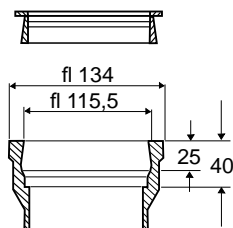
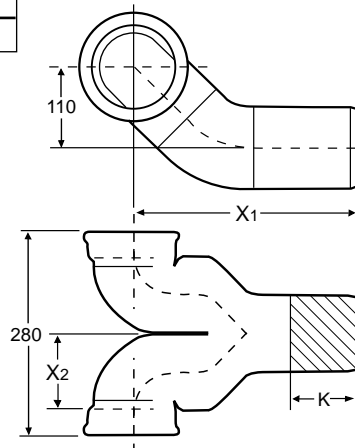

Alle WC-bend og grenrør har spesialmuffer med gummi-pakning tilpasset avløpsstus-sen på toalettet.

For å opprettholde en kontinuerlig produktutvikling forbeholder JOTI AS seg retten til å forandre tekniske spesifikasjoner uten forhåndsvarsel.

**Avsatsrør E = 75 mm**

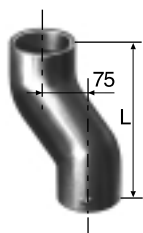

Ø	Art. nr. MA	L	Vekt kg	MA-SPECIAL
48	-			-
58	MU 05 C1EC*	185	1,1	-
75	MU 07 C1EC*	200	1,7	-
110	MU 10 C1EC*	215	2,4	-
135	MU 12 C1EC*	235	3,6	-
160	MU 15 C1EC*	255	5,35	-
210	MU 20 C1EC*	295	9,3	-
275	-			-
325	-			-

\* Ikke lagervare

**Avsatsrør E = 150 mm**

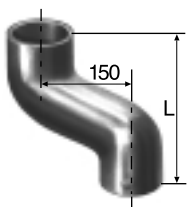

Ø	Art. nr. MA	L	Vekt kg	MA-SPECIAL
48	-			-
58	MU 05 C4EC*	210	1,5	-
75	MU 07 C4EC*	230	2,3	-
110	MU 10 C4EC*	250	3,2	-
135	MU 12 C4EC*	270	5,2	-
160	MU 15 C4EC*	300	7,0	-
210	MU 20 C4EC*	350	10,5	-
275	-			-
325	-			-

\* Ikke lagervare

**Forankringsrør**



Ø	Art. nr. MA	L	a	b	ø	Vekt kg	MA-SPECIAL
48							
58	NRF 200 80 94	200	195	150	93	2,10	
75	NRF 200 80 96	200	215	170	113	4,70	
110	NRF 200 80 98	200	250	214	147	3,60	
135	NRF 200 81 01	200	275	228	171	4,50	
160	NRF 200 81 03	200	300	255	186	6,00	
210	EP 20 AOFA*	200				8,30	
275	EP 25 AOFA**					12,10	
325	EP 30 AOFA**					16,10	

\* Ikke lagervare \*\* Avvikende utseende

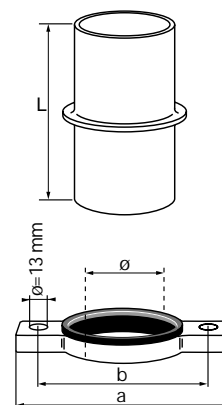

**Plast innstikkshylse for overgang fra MA til plastrør**

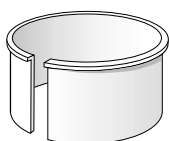

Ø	Ø2	Art. nr	B	E	Vekt kg
75		NRF 200 64 29			0,1
110		NRF 200 64 39			0,1

Gripekrage for røroppheng



For Normaconnect

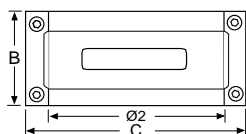

Ø	Ø2	For Normaconnect	B	C	Vekt kg	For SMU RN
48						
58	74	NRF 200 81 14*	69	113	0,31	
75	88	NRF 200 81 16*	69	135	0,39	
110	131	NRF 200 81 18*	81	180	1,00	
135	149	NRF 200 81 21*		195	1,11	
160	184	NRF 200 81 23*		234	1,23	
210		NRF 200 81 25*			2,25	
275			122	360	3,80	NRF 200 81 27*
325			122	420	3,90	NRF 200 81 29*



For SMU-RN

\* Ikke lagervare

Koblinger, Joti rød m/2 skruer



Ø	Ø2	Art. nr. MA	B	E	Vekt kg	Art. nr. Rustfri*
48	60	NRF 200 73 14	65	19	0,1	
58	68	NRF 200 73 19	65	19	0,1	NRF 200 75 19
75	85	NRF 200 73 29	65	19	0,2	NRF 200 75 29
110	120	NRF 200 73 39	65	19	0,3	NRF 200 75 39
135	145	NRF 200 73 49	65	19	0,3	NRF 200 75 49
160	170	NRF 200 73 59	65	19	0,4	NRF 200 75 59
210						
275						
325						



\* Rustfri kval. m/ pakn. nitril-gummi (oljebestandig)

Koblinger, rustfrie m/1 skrue



Normaconnect

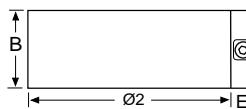

Ø	Ø2	Normaconnect	B	E	Vekt kg	SMU-RN
48		-			0,1	NRF 200 77 16
58	73	NRF 200 78 76	39		0,1	
75	89	NRF 200 78 79	39		0,2	
110	125	NRF 200 78 81	45		0,3	
135	147	NRF 200 78 84	55		0,3	
160	176	NRF 200 78 86	54		0,4	
210		NRF 200 78 88			0,6	



SMU-RN

Koblinger, rustfrie m/2 skruer for stor dimensjoner



SMU-S

Ø	Ø2	SMU-S	A	B	E	Vekt kg	SMU-RN
275	-				81	1,00	NRF 200 77 84
325	-				81	1,20	NRF 200 77 94
400	458	MU 40 JSE	139	12		7,05	
500	555	MU 50 JSE	140	12		-	
600	666	MU 60 JSE	140	12		-	



SMU-RN

For å opprettholde en kontinuerlig produktutvikling forbeholder JOTI AS seg retten til å forandre tekniske spesifikasjoner uten forhåndsvarsel.